

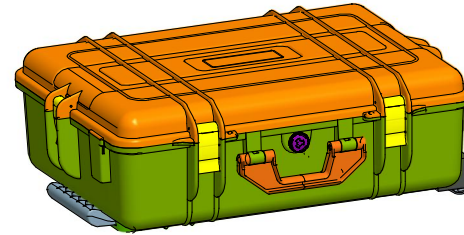

长河机箱  
Changhe Enclosures

<http://www.enclosures.com.cn>

A

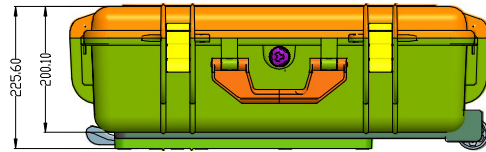

B

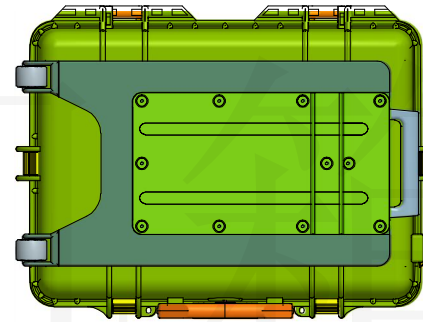
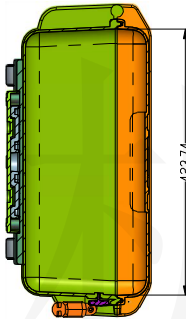
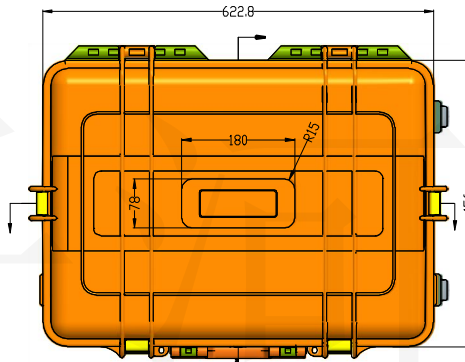
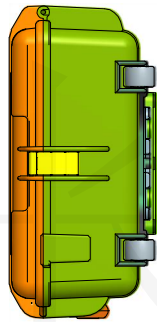

C

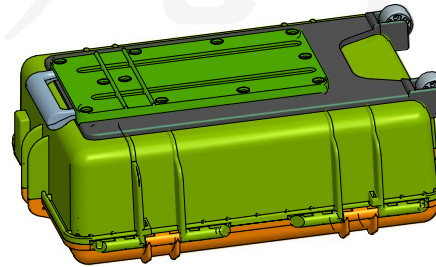
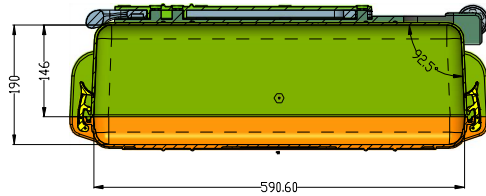

底图总号

D

旧底图总号

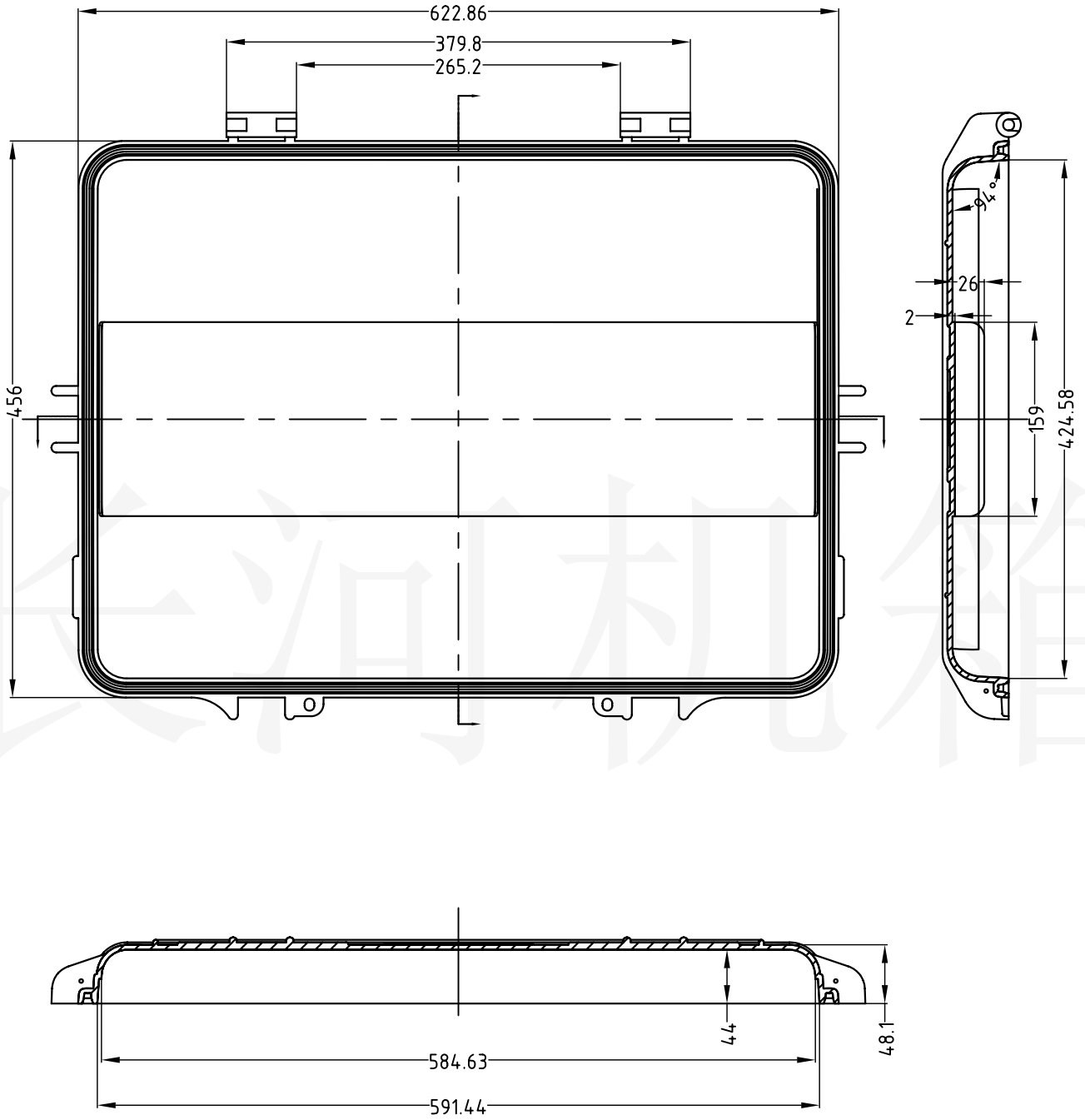

日期  
签字

制图 Drawing	审核 Auditing	批准 Confirm	产品名称 Product Name	壳体	材料 Material	
			产品编号 Product Code	37-8-1	视图 Project View	(mm)
					图纸比例 Drawing Scale	1:10
共 张 第 张			宁波大洋壳体有限公司 Ningbo Dayang Enclosures CO., LTD			

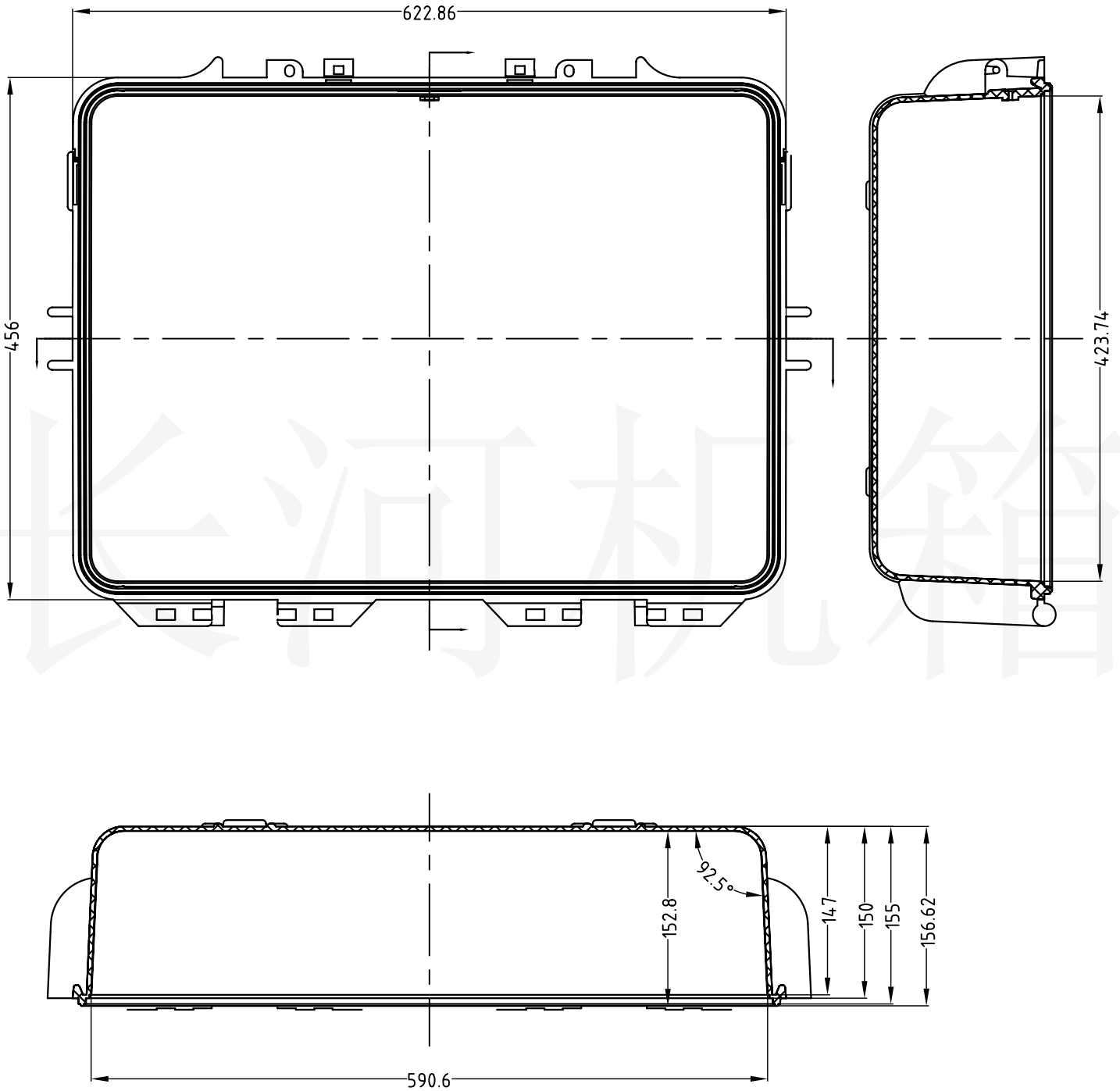

制图 Drawing	审核 Auditing	批准 Confirm	产品名称 Product Name	上盖	材料 Material	
			产品编号 Product Code	37-8-1	视图 Project View	(mm)
共 张 第 张					图纸比例 Drawing Scale	1:5
			宁波大洋壳体有限公司 Ningbo Dayang Enclosures CO., LTD			



制图 Drawing	审核 Auditing	批准 Confirm	产品名称 Product Name	底壳	材料 Material	 (mm)
			产品编号 Product Code		37-8-1	
共 张 第 张			 宁波大洋壳体有限公司 Ningbo Dayang Enclosures CO., LTD		1:5	